

Project Identity **Roma**

C257/X257



NATUZZI
EDITIONS

Index

- The project inspiration
- Dimensions and configurations
- Style Center proposals

The project
inspiration

Roma

For the design of this model, the Natuzzi Design Center was inspired by the Italian capital and its ancient streets, whose intersections draw perfect geometries that we find on the coating to enhance its shape majestic and slender at the same time. Modular and extremely versatile, Roma is equipped with adjustable armrests for personalized comfort, while the compass opening of the backrests offers two different depths with a single seat.



Embrace a new philosophy of Comfort.
Feelwell combines physical relaxation
and mental balance, offering a tailor-made
wellness experience.



Design by Natuzzi Design Center

In the Natuzzi Headquarter in Puglia, the Design Center preserves the balance between design and functionality, values rooted in the brand's DNA.



Dimensions and configurations

Choose your Roma

The Roma project is extremely versatile thanks to its components that allow us to create unlimited configurations suitable for any space, from the point of sale to our customers' homes.

Sofa with adjustable arms and backrests

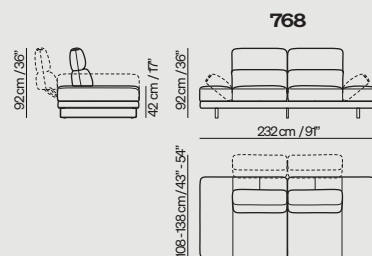

Corner seat with terminal and adjustable backrest

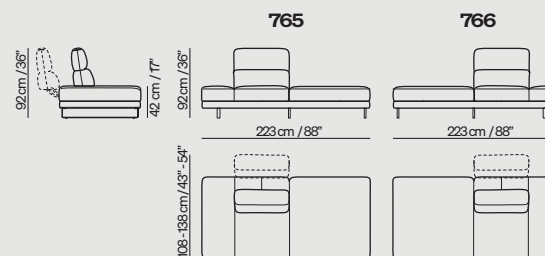

Sofa with adjustable arm and backrests

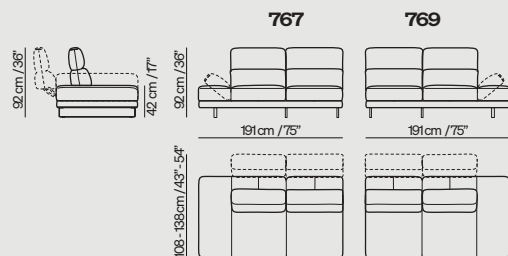

Seat with adjustable arm and backrests

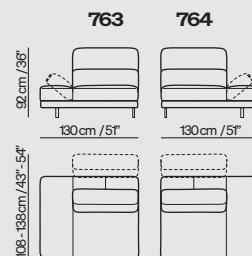

Seat with adjustable arm and backrests

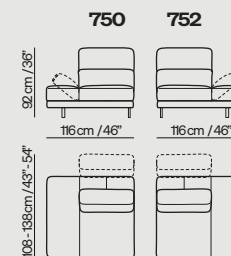

Armless seat with adjustable backrest

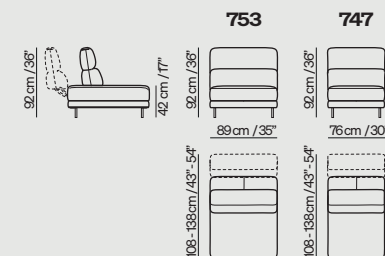

Wedge corner with adjustable backrest

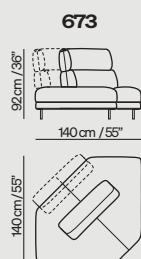

Corner without backrest

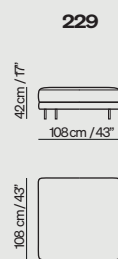

Seat with adjustable backrest and ceramic top terminal

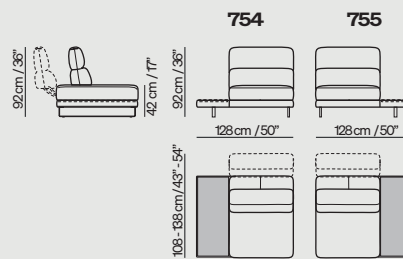

Large ottoman

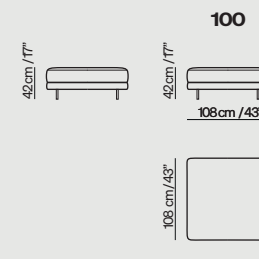

Self standing backrest

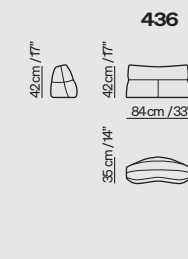

Versatility and configurations

The abacus «Versions and Compositions» shows all the versatility of the project. In particular, the Roma sofa offers seating solutions of different depths as in the examples below:



768

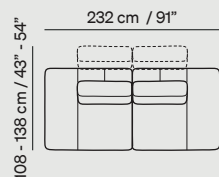

750+747+752

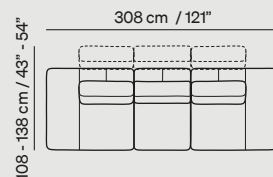

754+753+764

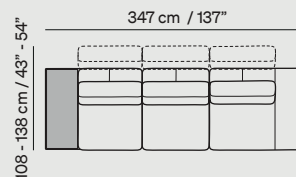

767+766+436

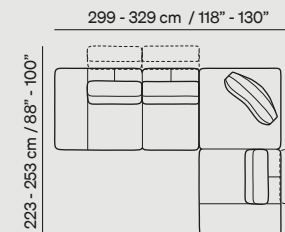

763+753+673+755

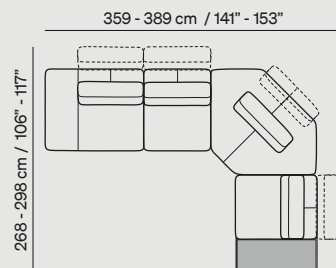

767+229+769+436

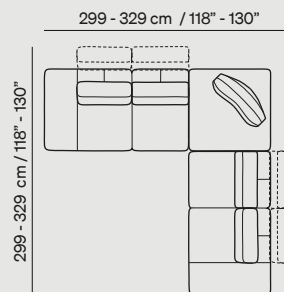

767+673+769

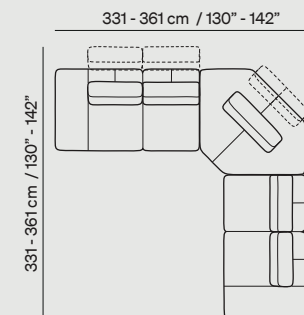

Thanks to the Configurator, it's possible to customize this versatility according to the customer's needs.

Features & Benefits



Manual adjustable headrest



Manually adjustable arms



Optional self-standing backrest headrest



Multiple configurations



Available in Leather and Fabric



Customizable foot finishings



Manually adjustable backrests that allow a double depth seating personalized and a relaxing experience.



Manual adjustable arms.



Optional «self-standing backrest» you can feel free to move and place as needed for back support.



Leather comes with «tufted» design and fabric comes with «plain» design.



Wedge corner module that includes the manually adjustable backrest.



Terminal module with side table-top in ceramic.

Style Center proposals

Get inspired by the Total Looks selected by our Style Center. Customize your project in Natuzzi Editions stores through the free interior design consultancy.

Moodboard green

The Natuzzi Style Center carefully selects materials and coverings, putting them in dialogue with each other. In this case, the Denver leather in the Bianco Ottico color was paired with the Cupido velvet in the moss color. The combination of these coverings together with the wood, will give rise to the moodboard that will create the final total look of the project. Each model in the collection is presented with multiple moodboards to adapt to homes all over the world.



Moodboard green

Together with the moodboard of coverings and materials, the Style Centre harmonizes the sofa with furniture and accessories to complete the interior design project.

768

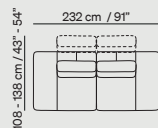

Sofa: Roma X257
Feet finish: FT 79 matt black

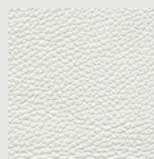

AOBY DENVER

767+766+436

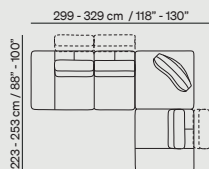

Sofa Sectional: Roma C257
Feet finish: FT 77 glossy chrome

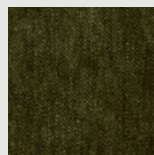

CUPIDO
78.0179.02

100+436



Ottoman with self standing backrest : Roma C257
Feet finish: FT 77 glossy chrome

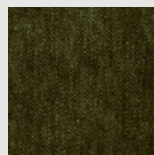

CUPIDO
78.0179.02



Central table: Wire
90 x 90 x H32 cm/35" x 35" x H13"
brown ash/brown matt metal
T042001XOF
Side table: Wire
D56 x H50 cm/D22" x H20"
brown ash/brown matt metal
T042004XOF



Lamp: Norma M
Multiple Sospension 5 White
L040006EOF



Pillows: Luxor
45 x 45 cm/18" x 18"
pearl/magnol green O926002XOF,
45 x 33 cm/18" x 13"
pearl/green O926009XOF



Rug: Trekking
200 x 300 cm/79" x 118"
greenV170001XOF



NATUZZI
EDITIONS